

# OILPATH

## MODEL OP 20 HYDRAULIC CONTROL VALVES SERIES PARALLEL CIRCUIT



The reliable choice for  
Agricultural and light industrial machinery  
Tractor remote requirements  
Closed centre hydraulics  
Front end loaders  
Wool presses

## FEATURES

- Proven monoblock construction
- High working pressure
- Very low leakage rate
- Power beyond facility
- Fully balanced spools
- Easily adjustable pilot relief valve
- Built in load checks on D and S configurations
- Open handle positions

## AVAILABLE CONFIGURATIONS

Can be ordered in any combination

**D** DOUBLE ACTING  
Spring centred

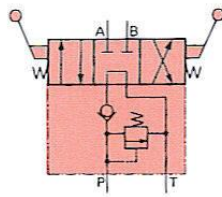

**M** MOTOR  
Spring centred

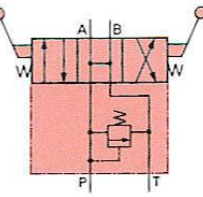

**L** DOUBLE ACTING  
HIGH FLOW  
Spring centred

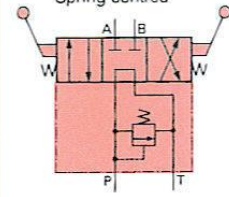

**S** SINGLE ACTING  
Spring centred

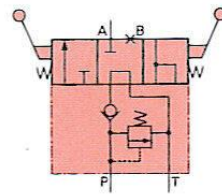

**K** FLOW CONTROL  
Friction detent

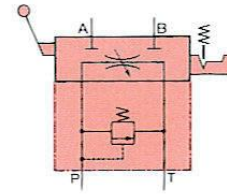

## SPECIFICATIONS

All valve bodies precision honed to the spools fitted	Relief valve adjustment range 4.14 MPa—20.68 MPa (600 psi—3000 psi)
High quality close grain castings	Outlet port 1 1/16 in. UNF 12 TPI 'O' ring. Remaining ports 7/8 in. UNF 14 TPI 'O' ring. <b>Note:</b> When high pressure carry over cap is fitted for power beyond, outlet port becomes 7/8 in. UNF 14 TPI 'O' ring.
Series parallel circuit	
Maximum working pressure 20.68 MPa (3000 psi)	

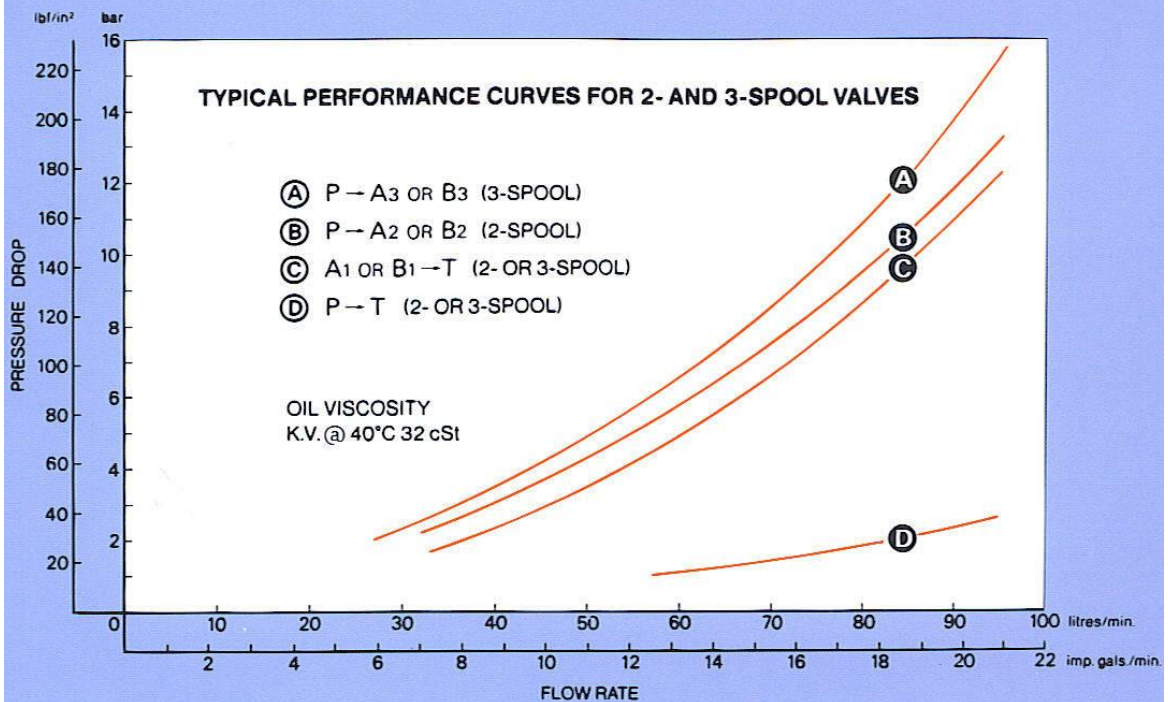

# TYPICAL INSTALLATIONS

## Open centre

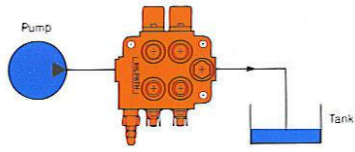

## Closed centre

Top port plug is removed and replaced with return hose to tank unrestricted.

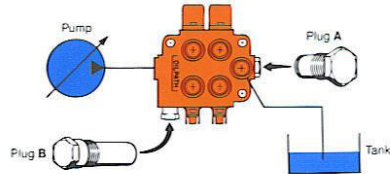

## Power beyond

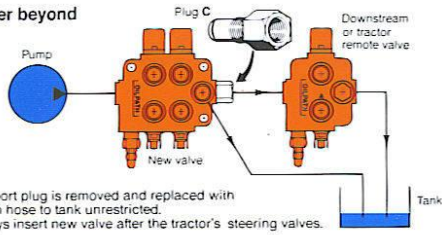

## Accessory plugs

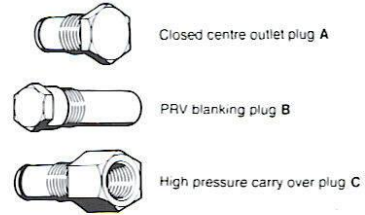

Dimensions (to nearest mm)					
Number of spools					
Dim	1	2	3	4	5
C	129	177	225	273	321
E	79	127	175	223	271
F	89				
G	67				
H	34				
I	27				
J	43				
K	11				
L	27				
M	39				
N	23				
O	48				
P	74				
Q	7				
S	252 (acorn nut closed)				
T	143				
U	Mounting hole 10.3 dia.				
V	33				

C, E: variable dimensions  
F-V: fixed dimensions

Specifications given in this brochure are correct at time of publication. The manufacturer reserves the right to change specifications without notice.

**DESIGNED & MANUFACTURED IN AUSTRALIA**

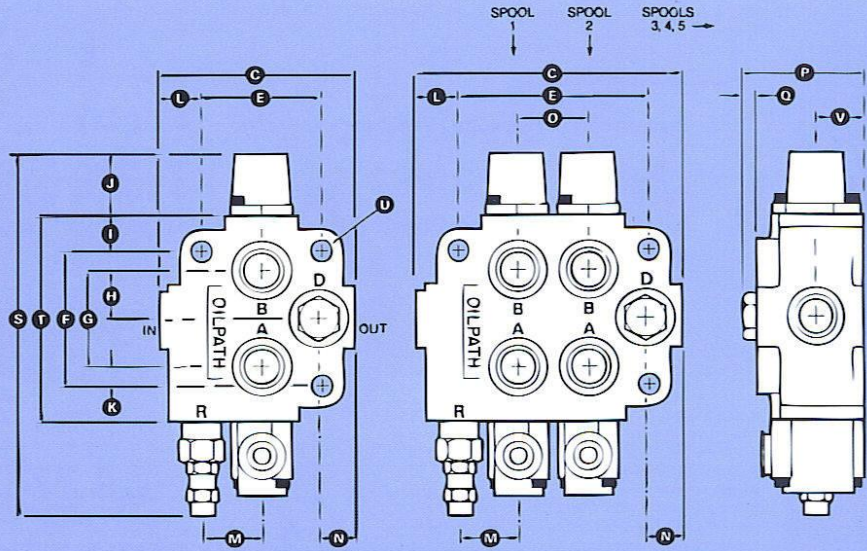

### Notes:

- When spool travels into body, port A becomes action. When spool is extended out from neutral, port B is action. This applies to all configurations.
- Port D is alternate outlet. When high pressure carry over is fitted, port D is connected to tank unrestricted.

### APPROXIMATE OPERATING CLEARANCES FOR HANDLE POSITIONS

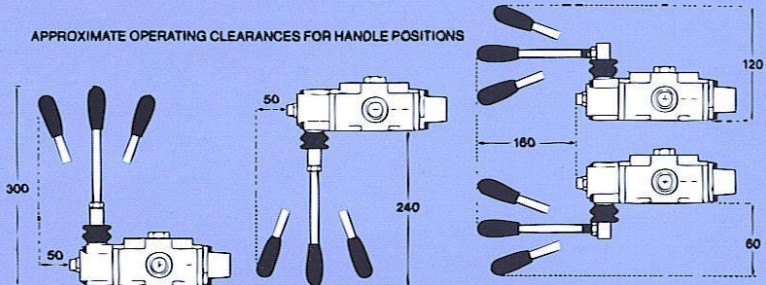

## ORDERING INFORMATION

Oilpath OP20 control valves may be ordered by quoting a number/letter group sequence as follows:

Valve series; Spool configuration; Relief setting; Options required.

VALVE MODEL	SPOOL CONFIGURATION Starting from inlet port	RELIEF SETTING	OPTIONS			
OP20	<b>D</b> Double acting spring centered	Specify pressure within the range 600 - 3000 psi (4.14 - 20.68 MPa)	<b>PB</b>	High pressure carry over.	<b>MU</b>	For mine and marine use.
	<b>S</b> Spring acting spring centered		<b>CC</b>	Closed centre.	<b>D*</b>	Three position detent.
	<b>M</b> Motor spring centered		<b>NR</b>	Relief valve not required.	<b>E*</b>	Electric limit switch.
	<b>K</b> Flow control spool controlled by infinite adjustment of friction detent. Can be positioned in any sequence of valve configuration, and only affects downstream spools. This is not pressure compensated. See note below.		<b>BF</b>	Bottom face outlet.	<b>A*</b>	Air control OP103.
	<b>L</b> Double acting spool with no load checks. Used in conjunction with 1 1/2" UNF service ports. Maximum capacity: 30 gal/min (1mp.). See note below.		<b>SC</b>	Spring centred detent.	<b>R*</b>	Cable control Morse RVC.
			<b>HI-FLOW</b>	High flow. See note below.	<b>J*</b>	Proportional air control.
			<b>SERIES</b>	Series circuitry. 2 spool model only. See note below.	<b>H*</b>	On-valve aux. control.

EXAMPLES: **OP20 D 2000 PB**  
**OP20 DD 2000**  
**OP20 DSD 1500 D13**

\* Code letter to be followed by numeral indicating for which spool option is required (counting from inlet)

Single spool, double acting spring centred 2000 psi relief. High pressure carry over.

Double spool, 1st spool double acting spring centred, 2nd spool double acting spring centred. Relief valve 2000 psi.

Triple spool, 1st spool double acting with detent, 2nd spool single acting spring centred, 3rd spool double acting with detent 1500 psi relief.

### K and L configurations

When ordering K and L configurations please refer to your distributor or the factory for further information to assist in correct circuit design.

### Series circuit

Only the two spool OP20 valve is available with optional series circuitry. Please consult your distributor or the factory for further information.

### Hi-flow

Valve is supplied with 3/4" BSPT ports, R2 relief and special D or S spools as required.

### WARRANTY

*Oilpath products are warranted to be free of defects in material or workmanship.*

*This Warranty voids all other warranties, whether expressed or implied, and shall be in effect for six months from date of purchase.*

*The Warranty is limited to replacement or repair, excluding seals or damage arising from misuse or incorrect installation.*

*The Company accepts no liability for faults caused by improper use or faulty maintenance of the product or its operation beyond recommended specifications, or contingent or consequential loss or damage under any situation whatsoever.*

*All unauthorised modifications to the product automatically voids the conditions of this Warranty.*



10-14 MAUD STREET, NEWSTEAD, 4006  
 P.O. BOX 50, FORTITUDE VALLEY, 4006  
 Email: sales@industrialhyd.com.au

**PHONE: (07) 3854 1232**

**FAX: (07) 3252 2346**